

INSTALLATION INSTRUCTIONS

ALSAN® PRE-CUT FLEECE UNIVERSAL CORNER INSTALLATION INSTRUCTIONS

ALSAN PRE-CUT FLEECE UNIVERSAL CORNER (6" x 6")

ALSAN Pre-Cut Fleece is offered to improve the efficiency and quality of application for typical penetrations found on most roofing and waterproofing projects where ALSAN RS or ALSAN Flashing is installed. These instructions should be used in conjunction with the SOPREMA ALSAN RS Guide, SOPREMA SBS Roofing Manual, applicable Product Data Sheets (PDS), material Safety Data Sheets (SDS), specifications, and other published technical recommendations, guidelines, or documentation. Prior to application, persons handling or applying ALSAN RS and ALSAN Flashing components should familiarize themselves with all health, safety, environment related hazards, precautions, Personal Protective Equipment (PPE) and protective measures as may be required. The applicator is responsible for ensuring conditions are appropriate to proceed and proper application methods are followed.

PRE-CUT FLEECE COMPONENTS

ALSAN Pre-Cut Fleece Universal Corner may be used for all inside and outside corner applications. The universal corner is pre-cut for bottom outside corners and requires a single cut for top outside and bottom inside corner applications.

INSTALLING BOTTOM OUTSIDE CORNER

Install the pre-cut fleece corner using a catalyzed basecoat and topcoat of ALSAN RS resin or single component ALSAN Flashing. The "A", "B" & "C" dimensions in the diagram below represent the flashing base height, deck flange and corner wrap respectively.

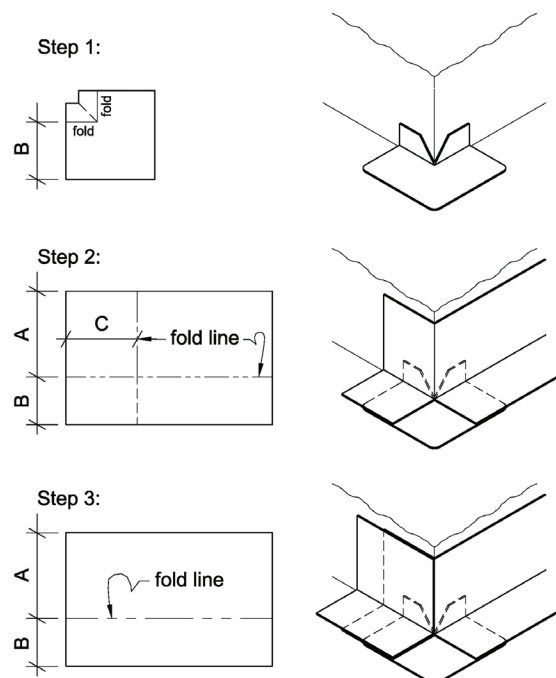

Install the pre-cut fleece corner lining up the split at 45 degrees so one clipped end is applied vertically on each side of the corner. Once the corner is set, apply the corner flashing right and left panels as required in a catalyzed basecoat and topcoat of ALSAN RS resin or single component ALSAN Flashing.

CUTTING FOR BOTTOM INSIDE/TOP OUTSIDE CORNERS

For inside bottom and outside top corner applications, fold the pre-cut fleece corner in half and then quarter with the clipped ends on the outside up and to the right, then cut the fleece along the fold down to the center point.

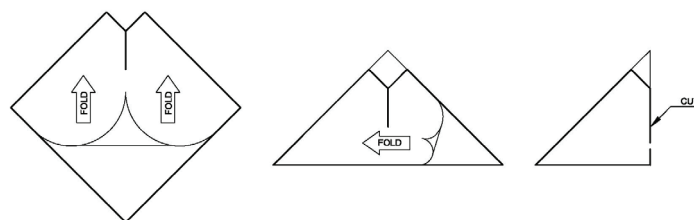

The corner is now ready for inside bottom or outside top corner applications.

INSTALLING BOTTOM INSIDE CORNER

After making the center cut, pull the right and left sides with clipped ends together aligning the straight edge forming a three sided cone.

Step 1:

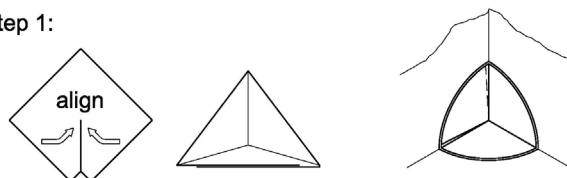

Step 2:

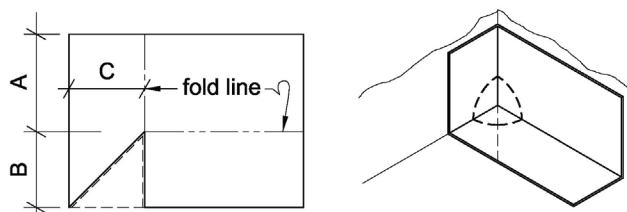

Step 3:

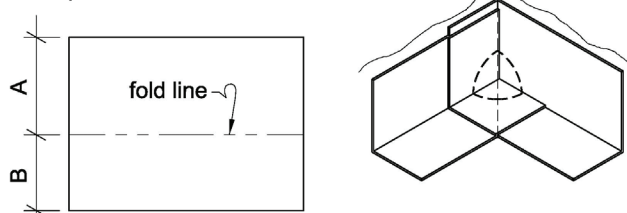

Install the pre-cut fleece corner with the overlap down using a catalyzed basecoat and topcoat of ALSAN RS resin or single component ALSAN Flashing. The "A", "B" & "C" dimensions in the diagram below represent the flashing base.

INSTALLATION INSTRUCTIONS

ALSAN® PRE-CUT FLEECE UNIVERSAL CORNER INSTALLATION INSTRUCTIONS

height, deck flange and corner wrap respectively. Once the corner is set, apply the corner flashing right and left panels as required in a catalyzed basecoat and topcoat of ALSAN RS resin "C" dimensions in the diagram below represent the flashing base.

INSTALLING TOP OUTSIDE CORNER

After making the center cut, pull the right and left sides with clipped ends together aligning the straight edge forming a three sided cone.

Step 1:

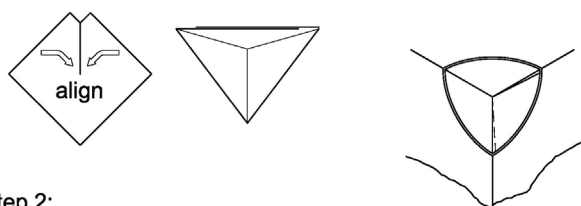

Step 2:

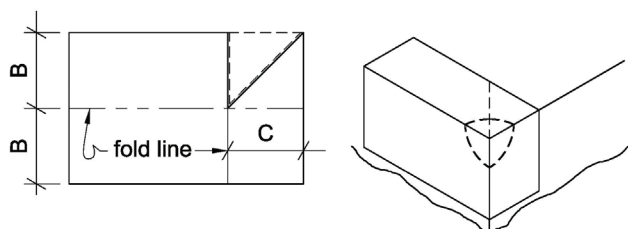

Step 3:

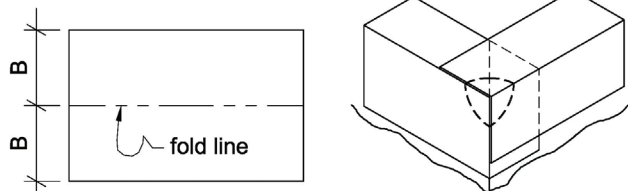

Install the pre-cut fleece corner with the overlap up using a catalyzed basecoat and topcoat of ALSAN RS resin "C" dimensions in the diagram below represent the flashing base. The "B" & "C" dimensions in the diagram below represent the flashing flange and corner wrap respectively. Once the corner is set, apply the corner flashing right and left panels as required applied in a catalyzed basecoat and topcoat of ALSAN RS resin or single component ALSAN Flashing.

DISCLAIMER

The applicator is responsible for ensuring conditions are appropriate to proceed with proper application methods. Refer to SOPREMA product, specifications and guides for additional information. Materials and methods should be adjusted as necessary to accommodate varying project conditions. Materials should not be installed when conditions are unacceptable to achieve the specified results.