

Roll Width (Y)	Lap Width (Z)	Row Spacing (X)	Fasteners Per Square
36in (0.9m)	2in	11.33in	212
36in (0.9m)	3in	11in	218
36in (0.9m)	4in	10.67in	225
39in (1m)	3in	12in	200
39in (1m)	4in	11.67in	206

6,6,6 BASE SHEET FASTENING PATTERN

- ONE (1) ROW AT SIDE LAPS SPACED 6" O.C.
- TWO (2) EQUALLY SPACED INTERMEDIATE ROWS SPACED 6" O.C. AND STAGGERED

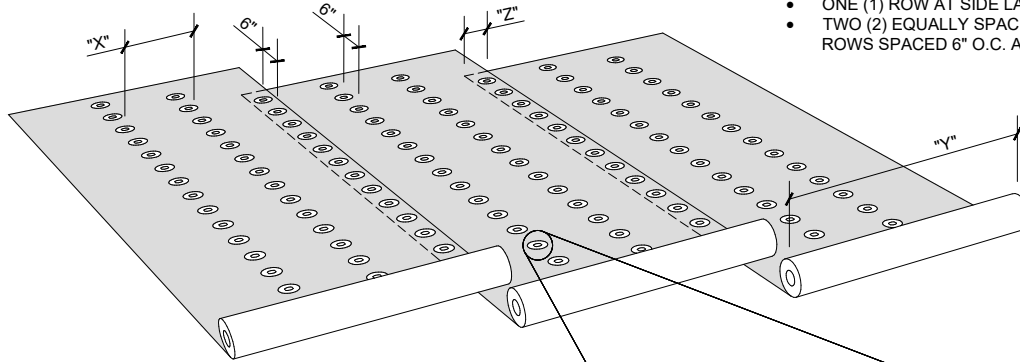

FASTENING PATTERN FOR SHADED AREAS

ROOF HEIGHT LESS THAN OR EQUAL TO 60ft

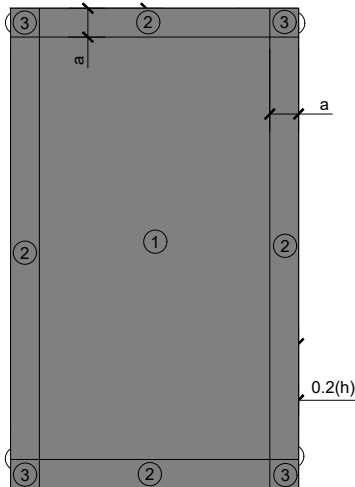

ROOF HEIGHT GREATER THAN 60ft

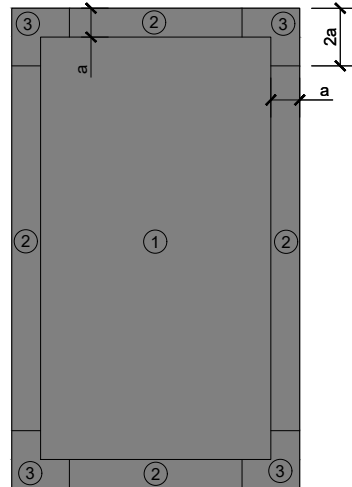

$a = 40\%$ of least horizontal dimension or 40% of eave height, whichever is smaller, but not less than either 4% of least horizontal dimension or 3ft

$a = 10\%$ of least horizontal roof dimension, but not less than 3ft

ASCE 7-16 ROOF ZONES (LOW-SLOPE ROOFS $\theta \leq 7^\circ$)

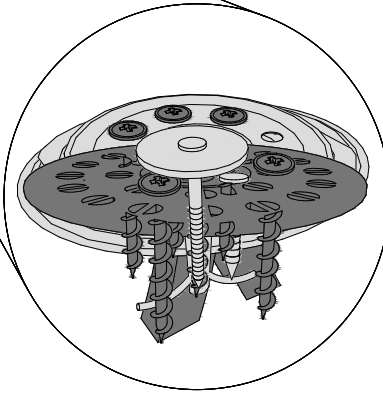

FASTENING PATTERN

NOTES:

1. SOPREMA DETAIL DRAWINGS: REFER TO SOPREMA AND OTHER RELATED PUBLISHED DOCUMENTATION, PRODUCT DATA SHEETS (PDS) AND SAFETY DATA SHEETS (SDS) FOR ADDITIONAL INFORMATION. ALL DETAIL DRAWINGS AND RELATED INSTALLATION GUIDELINES ARE PROVIDED BY SOPREMA FOR THE SOLE PURPOSE OF ISSUING A SOPREMA WARRANTY. ACCORDINGLY, THE DETAIL DRAWINGS ARE NOT OFFERED, AND SHOULD NOT BE CONSIDERED, AS A SUBSTITUTE FOR PROFESSIONAL DESIGN SERVICES.
2. SOPREMA NOR ITS EMPLOYEES ARE DESIGNER OF RECORD FOR ANY PROJECT. FASTENING PATTERNS PROVIDED BY SOPREMA ARE FOR SOPREMA WARRANTY PURPOSES ONLY. REFER TO LOCAL BUILDING CODES, DESIGNER OF RECORD DOCUMENTS, AND JURISDICTIONAL/AGENCY APPROVALS FOR PROJECT-SPECIFIC FASTENING REQUIREMENTS.
3. ROOF ZONE GUIDELINES PROVIDED HEREIN ARE OFFERED FOR REFERENCE. REFER TO ASCE/SEI 7 FOR SPECIFIC REQUIREMENTS.



US CORPORATE ADDRESS
310 QUADRAL DRIVE
WADSWORTH, OHIO 44281
www.soprema.us
Tel:330.334.0066

PROJECT:

TITLE:

6,6,6 BASE SHEET FASTENING PATTERN

DRAWN BY: SOPREMA TECHNICAL SUPPORT, GGALLOWAY

NO.:

REVISION:

DATE:

DATE: 12.12.2019

SCALE: NTS

DRAWING NUMBER:
US.FP.01.01