

Roll Width (Y)	Lap Width (Z)	Row Spacing (X)	Fasteners Per Square
36in (0.9m)	2in	11.33in	121
36in (0.9m)	3in	11in	125
36in (0.9m)	4in	10.67in	129
39in (1m)	3in	12in	115
39in (1m)	4in	11.67in	118

7,14,14 BASE SHEET FASTENING PATTERN

- ONE (1) ROW AT SIDE LAPS SPACED 7" O.C.
- TWO (2) EQUALLY SPACED INTERMEDIATE ROWS SPACED 14" O.C. AND STAGGERED

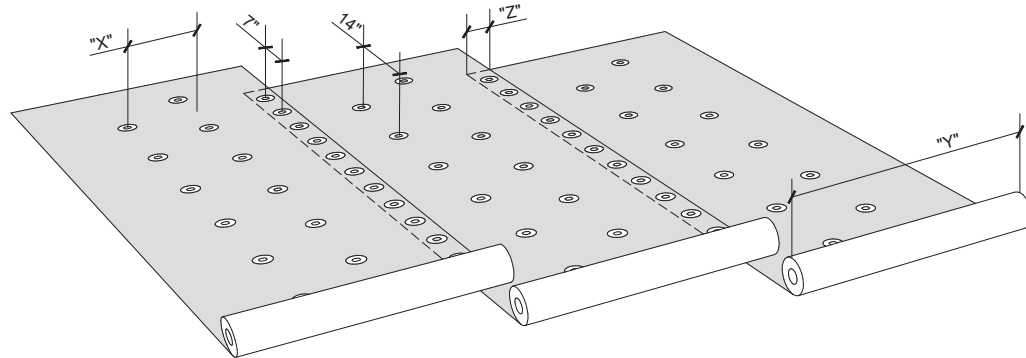

NOTES:

1. SOPREMA DETAIL DRAWINGS: REFER TO SOPREMA AND OTHER RELATED PUBLISHED DOCUMENTATION, PRODUCT DATA SHEETS (PDS) AND SAFETY DATA SHEETS (SDS) FOR ADDITIONAL INFORMATION. ALL DETAIL DRAWINGS AND RELATED INSTALLATION GUIDELINES ARE PROVIDED BY SOPREMA FOR THE SOLE PURPOSE OF ISSUING A SOPREMA WARRANTY. ACCORDINGLY, THE DETAIL DRAWINGS ARE NOT OFFERED, AND SHOULD NOT BE CONSIDERED, AS A SUBSTITUTE FOR PROFESSIONAL DESIGN SERVICES.
2. SOPREMA NOR ITS EMPLOYEES ARE DESIGNER OF RECORD FOR ANY PROJECT. FASTENING PATTERNS PROVIDED BY SOPREMA ARE FOR SOPREMA WARRANTY PURPOSES ONLY. REFER TO LOCAL BUILDING CODES, DESIGNER OF RECORD DOCUMENTS, AND JURISDICTIONAL/AGENCY APPROVALS FOR PROJECT-SPECIFIC FASTENING REQUIREMENTS.
3. ROOF ZONE GUIDELINES PROVIDED HEREIN ARE OFFERED FOR REFERENCE. REFER TO ASCE/SEI 7 FOR SPECIFIC REQUIREMENTS.



US CORPORATE ADDRESS
 310 QUADRAL DRIVE
 WADSWORTH, OHIO 44281
www.soprema.us
 Tel:330.334.0066

PROJECT:

TITLE:

7,14,14 BASE SHEET FASTENING PATTERN

DRAWN BY: SOPREMA TECHNICAL SUPPORT, GGALLOWAY

NO.:

REVISION:

DATE:

DATE: 2.17.2020

SCALE: NTS

DRAWING NUMBER:
US.FP.01.10