

Roll Width (Y)	Lap Width (Z)	Row Spacing (X)	Fasteners Per Square
39in (1m)	4in	35in	23
39in (1m)	5in	34in	24
39in (1m)	6in	33in	25

18" O.C. IN LAP FASTENING PATTERN

- ONE (1) ROW WITHIN THE CENTER OF THE SIDE LAPS SPACED 18" O.C.

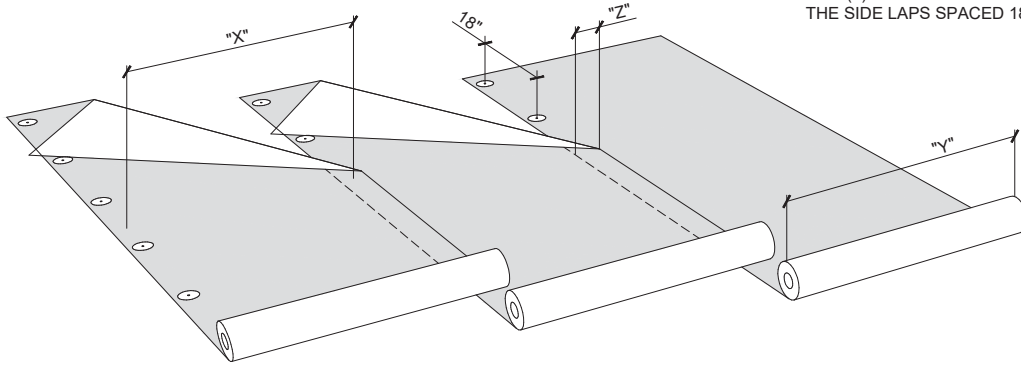

NOTES:

1. SOPREMA DETAIL DRAWINGS: REFER TO SOPREMA AND OTHER RELATED PUBLISHED DOCUMENTATION, PRODUCT DATA SHEETS (PDS) AND SAFETY DATA SHEETS (SDS) FOR ADDITIONAL INFORMATION. ALL DETAIL DRAWINGS AND RELATED INSTALLATION GUIDELINES ARE PROVIDED BY SOPREMA FOR THE SOLE PURPOSE OF ISSUING A SOPREMA WARRANTY. ACCORDINGLY, THE DETAIL DRAWINGS ARE NOT OFFERED, AND SHOULD NOT BE CONSIDERED, AS A SUBSTITUTE FOR PROFESSIONAL DESIGN SERVICES.
2. SOPREMA NOR ITS EMPLOYEES ARE DESIGNER OF RECORD FOR ANY PROJECT. FASTENING PATTERNS PROVIDED BY SOPREMA ARE FOR SOPREMA WARRANTY PURPOSES ONLY. REFER TO LOCAL BUILDING CODES, DESIGNER OF RECORD DOCUMENTS, AND JURISDICTIONAL/AGENCY APPROVALS FOR PROJECT-SPECIFIC FASTENING REQUIREMENTS.
3. ROOF ZONE GUIDELINES PROVIDED HEREIN ARE OFFERED FOR REFERENCE. REFER TO ASCE/SEI 7 FOR SPECIFIC REQUIREMENTS.



US CORPORATE ADDRESS
 310 QUADRAL DRIVE
 WADSWORTH, OHIO 44281
www.soprema.us
 Tel:330.334.0066

PROJECT:

TITLE:

MECHANICALLY ATTACHED BASE PLY,
 18" O.C. IN LAP FASTENING PATTERN

DRAWN BY: SOPREMA TECHNICAL SUPPORT, GGALLOWAY

NO.:

REVISION:

DATE:

DATE: 12.16.2019

SCALE: NTS

DRAWING NUMBER:
US.FP.06.02