

ZONE 1

- ONE (1) ROW WITHIN THE CENTER OF THE SIDE LAPS SPACED 18" O.C.

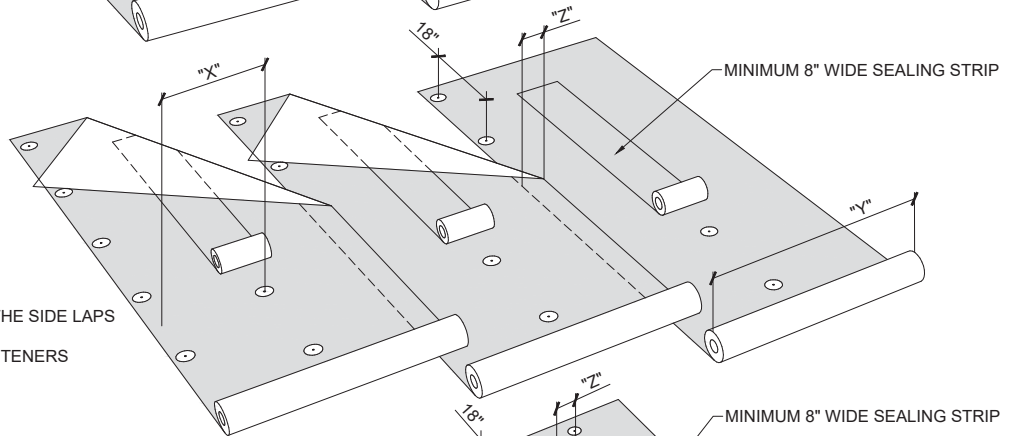

ZONE 2

- NOMINAL 60% OF FIELD ROW SPACING
- ONE (1) ROW WITHIN THE CENTER OF THE SIDE LAPS SPACED 18" O.C.
- ONE (1) INTERMEDIATE ROW, WITH FASTENERS SPACED 18" O.C. AND STAGGERED

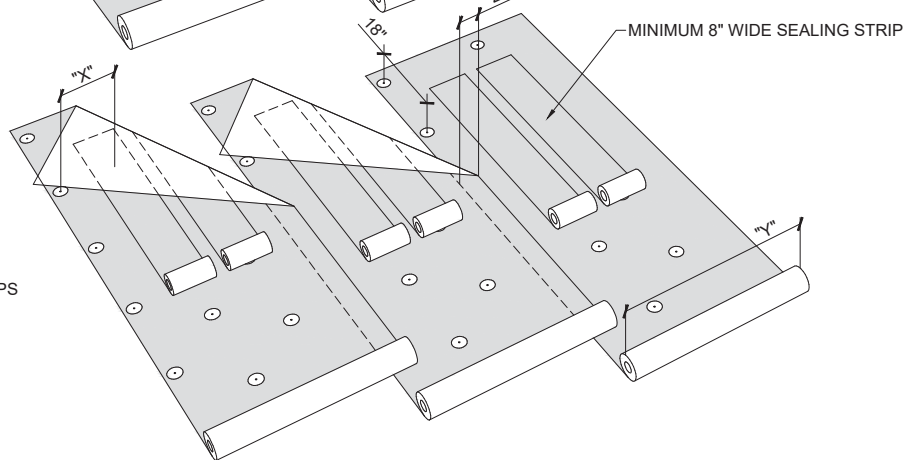

ZONE 3

- NOMINAL 40% OF FIELD ROW SPACING
- ONE (1) ROW WITHIN THE CENTER OF THE SIDE LAPS SPACED 18" O.C.
- TWO (2) INTERMEDIATE ROWS, WITH FASTENERS SPACED 18" O.C. AND STAGGERED

Roll Width (Y)	Lap Width (Z)	Zone	Pattern	Row Spacing (X)	Fasteners Per Square
39in (1m)	4in	1	18	35in	23
		2	18,18	17.5in	46
		3	18,18,18	11.67in	69
39in (1m)	5in	1	18	34in	24
		2	18,18	17in	48
		3	18,18,18	11.33in	71
39in (1m)	6in	1	18	33in	25
		2	18,18	16.5in	49
		3	18,18,18	11in	73

NOTES:

1. SOPREMA DETAIL DRAWINGS: REFER TO SOPREMA AND OTHER RELATED PUBLISHED DOCUMENTATION, PRODUCT DATA SHEETS (PDS) AND SAFETY DATA SHEETS (SDS) FOR ADDITIONAL INFORMATION. ALL DETAIL DRAWINGS AND RELATED INSTALLATION GUIDELINES ARE PROVIDED BY SOPREMA FOR THE SOLE PURPOSE OF ISSUING A SOPREMA WARRANTY. ACCORDINGLY, THE DETAIL DRAWINGS ARE NOT OFFERED, AND SHOULD NOT BE CONSIDERED, AS A SUBSTITUTE FOR PROFESSIONAL DESIGN SERVICES.
2. SOPREMA NOR ITS EMPLOYEES ARE DESIGNER OF RECORD FOR ANY PROJECT. FASTENING PATTERNS PROVIDED BY SOPREMA ARE FOR SOPREMA WARRANTY PURPOSES ONLY. REFER TO LOCAL BUILDING CODES, DESIGNER OF RECORD DOCUMENTS, AND JURISDICTIONAL/AGENCY APPROVALS FOR PROJECT-SPECIFIC FASTENING REQUIREMENTS.



US CORPORATE ADDRESS
 310 QUADRAL DRIVE
 WADSWORTH, OHIO 44281
 www.soprema.us
 Tel:330.334.0066

PROJECT:

TITLE: MECHANICALLY ATTACHED BASE PLY,
 18" O.C. IN LAP FASTENING PATTERN
 AND PRESCRIPTIVE ENHANCEMENTS

DRAWN BY: SOPREMA TECHNICAL SUPPORT, GGALLOWAY

NO.:

REVISION:

DATE:

DATE: 12.23.2019

SCALE: NTS

DRAWING NUMBER:
US.FP.16.02