

ZONE 1

- ONE (1) ROW WITHIN THE CENTER OF THE SIDE LAPS SPACED 10" O.C.

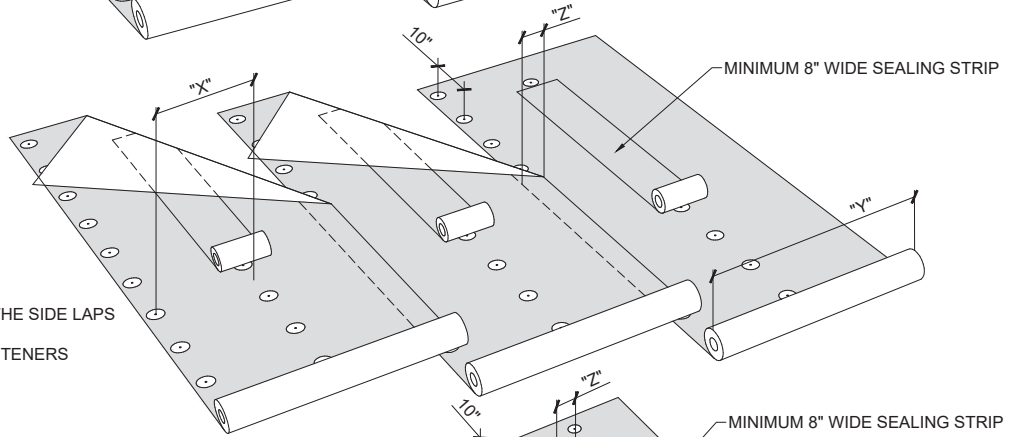

ZONE 2

- NOMINAL 60% OF FIELD ROW SPACING
- ONE (1) ROW WITHIN THE CENTER OF THE SIDE LAPS SPACED 10" O.C.
- ONE (1) INTERMEDIATE ROW, WITH FASTENERS SPACED 10" O.C. AND STAGGERED

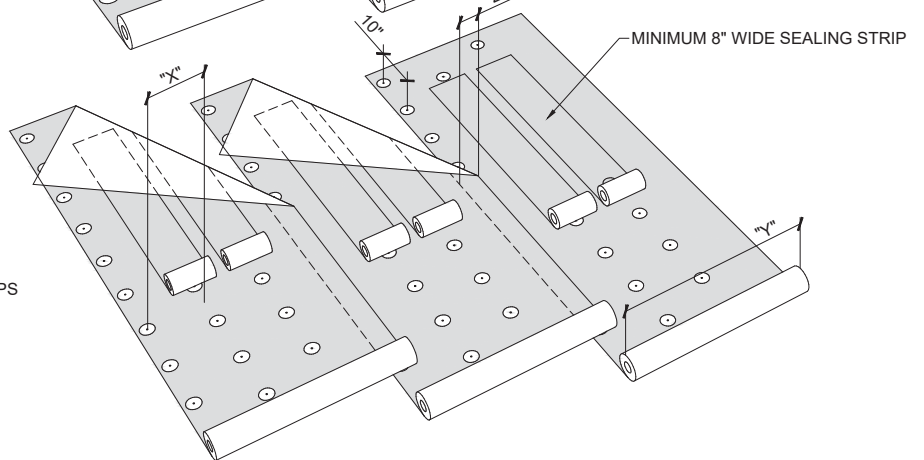

ZONE 3

- NOMINAL 40% OF FIELD ROW SPACING
- ONE (1) ROW WITHIN THE CENTER OF THE SIDE LAPS SPACED 10" O.C.
- TWO (2) INTERMEDIATE ROWS, WITH FASTENERS SPACED 10" O.C. AND STAGGERED

Roll Width (Y)	Lap Width (Z)	Zone	Pattern	Row Spacing (X)	Fasteners Per Square
39in (1m)	4in	1	10	35in	42
		2	10,10	17.5in	83
		3	10,10,10	11.67in	124
39in (1m)	5in	1	10	34in	43
		2	10,10	17in	85
		3	10,10,10	11.33in	128
39in (1m)	6in	1	10	33in	44
		2	10,10	16.5in	88
		3	10,10,10	11in	131

NOTES:

1. SOPREMA DETAIL DRAWINGS: REFER TO SOPREMA AND OTHER RELATED PUBLISHED DOCUMENTATION, PRODUCT DATA SHEETS (PDS) AND SAFETY DATA SHEETS (SDS) FOR ADDITIONAL INFORMATION. ALL DETAIL DRAWINGS AND RELATED INSTALLATION GUIDELINES ARE PROVIDED BY SOPREMA FOR THE SOLE PURPOSE OF ISSUING A SOPREMA WARRANTY. ACCORDINGLY, THE DETAIL DRAWINGS ARE NOT OFFERED, AND SHOULD NOT BE CONSIDERED, AS A SUBSTITUTE FOR PROFESSIONAL DESIGN SERVICES.
2. SOPREMA NOR ITS EMPLOYEES ARE DESIGNER OF RECORD FOR ANY PROJECT. FASTENING PATTERNS PROVIDED BY SOPREMA ARE FOR SOPREMA WARRANTY PURPOSES ONLY. REFER TO LOCAL BUILDING CODES, DESIGNER OF RECORD DOCUMENTS, AND JURISDICTIONAL/AGENCY APPROVALS FOR PROJECT-SPECIFIC FASTENING REQUIREMENTS.



US CORPORATE ADDRESS
 310 QUADRAL DRIVE
 WADSWORTH, OHIO 44281
 www.soprema.us
 Tel:330.334.0066

PROJECT:

TITLE: MECHANICALLY ATTACHED BASE PLY,
 10" O.C. IN LAP FASTENING PATTERN
 AND PRESCRIPTIVE ENHANCEMENTS

DRAWN BY: SOPREMA TECHNICAL SUPPORT, GGALLOWAY

NO.:

REVISION:

DATE:

DATE: 1.30.2020

SCALE: NTS

DRAWING NUMBER:
US.FP.16.04