

ZONE 1

- ONE (1) ROW WITHIN THE CENTER OF THE SIDE LAPS SPACED 8" O.C.

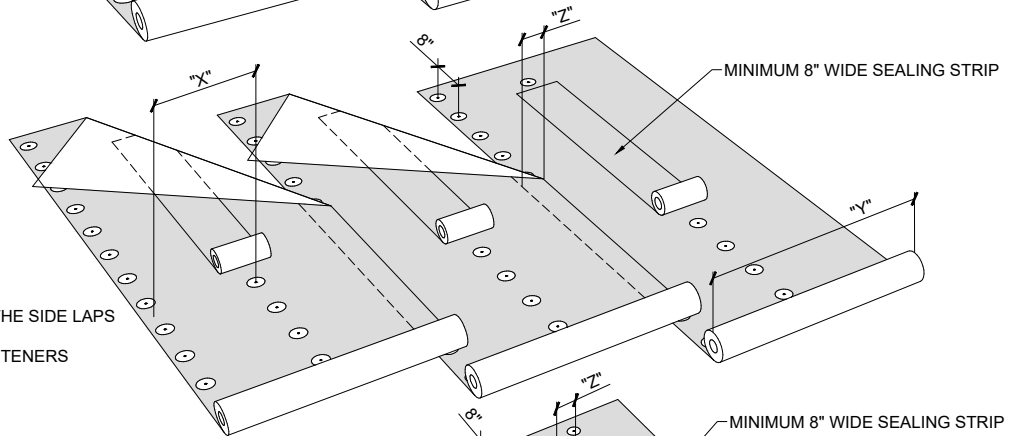

ZONE 2

- NOMINAL 60% OF FIELD ROW SPACING
- ONE (1) ROW WITHIN THE CENTER OF THE SIDE LAPS SPACED 8" O.C.
- ONE (1) INTERMEDIATE ROW, WITH FASTENERS SPACED 8" O.C. AND STAGGERED

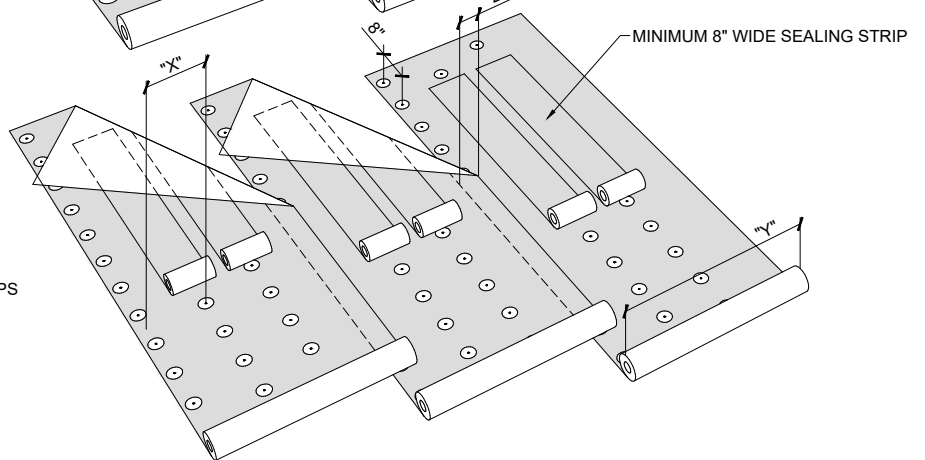

ZONE 3

- NOMINAL 40% OF FIELD ROW SPACING
- ONE (1) ROW WITHIN THE CENTER OF THE SIDE LAPS SPACED 8" O.C.
- TWO (2) INTERMEDIATE ROWS, WITH FASTENERS SPACED 8" O.C. AND STAGGERED

Roll Width (Y)	Lap Width (Z)	Zone	Pattern	Row Spacing (X)	Fasteners Per Square
39in (1m)	4in	1	8	35in	52
		2	8,8	17.5in	103
		3	8,8,8	11.67in	155
39in (1m)	5in	1	8	34in	53
		2	8,8	17in	106
		3	8,8,8	11.33in	159
39in (1m)	6in	1	8	33in	55
		2	8,8	16.5in	110
		3	8,8,8	11in	164

NOTES:

1. SOPREMA DETAIL DRAWINGS: REFER TO SOPREMA AND OTHER RELATED PUBLISHED DOCUMENTATION, PRODUCT DATA SHEETS (PDS) AND SAFETY DATA SHEETS (SDS) FOR ADDITIONAL INFORMATION. ALL DETAIL DRAWINGS AND RELATED INSTALLATION GUIDELINES ARE PROVIDED BY SOPREMA FOR THE SOLE PURPOSE OF ISSUING A SOPREMA WARRANTY. ACCORDINGLY, THE DETAIL DRAWINGS ARE NOT OFFERED, AND SHOULD NOT BE CONSIDERED, AS A SUBSTITUTE FOR PROFESSIONAL DESIGN SERVICES.
2. SOPREMA NOR ITS EMPLOYEES ARE DESIGNER OF RECORD FOR ANY PROJECT. FASTENING PATTERNS PROVIDED BY SOPREMA ARE FOR SOPREMA WARRANTY PURPOSES ONLY. REFER TO LOCAL BUILDING CODES, DESIGNER OF RECORD DOCUMENTS, AND JURISDICTIONAL/AGENCY APPROVALS FOR PROJECT-SPECIFIC FASTENING REQUIREMENTS.



US CORPORATE ADDRESS
310 QUADRAL DRIVE
WADSWORTH, OHIO 44281
www.soprema.us
Tel:330.334.0066

PROJECT:

TITLE: MECHANICALLY ATTACHED BASE PLY,
8" O.C. IN LAP FASTENING PATTERN
AND PRESCRIPTIVE ENHANCEMENTS

DRAWN BY: SOPREMA TECHNICAL SUPPORT, GGALLOWAY

NO.:

REVISION:

DATE:

DATE: 4.27.2020

SCALE: NTS

DRAWING NUMBER:
US.FP.16.06