

ZONE 1

- ONE (1) ROW WITHIN THE CENTER OF THE SIDE LAPS SPACED 24" O.C.

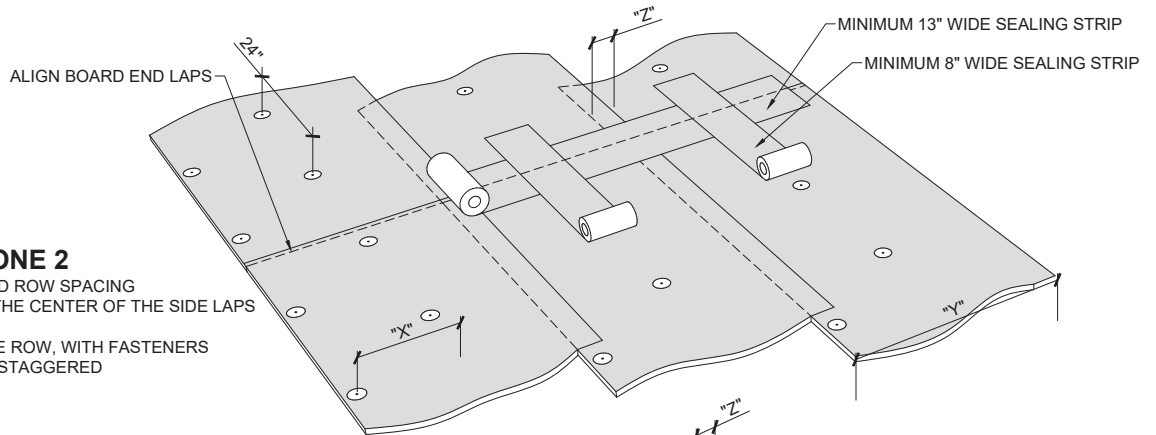

ZONE 2

- NOMINAL 60% OF FIELD ROW SPACING
- ONE (1) ROW WITHIN THE CENTER OF THE SIDE LAPS SPACED 24" O.C.
- ONE (1) INTERMEDIATE ROW, WITH FASTENERS SPACED 24" O.C. AND STAGGERED

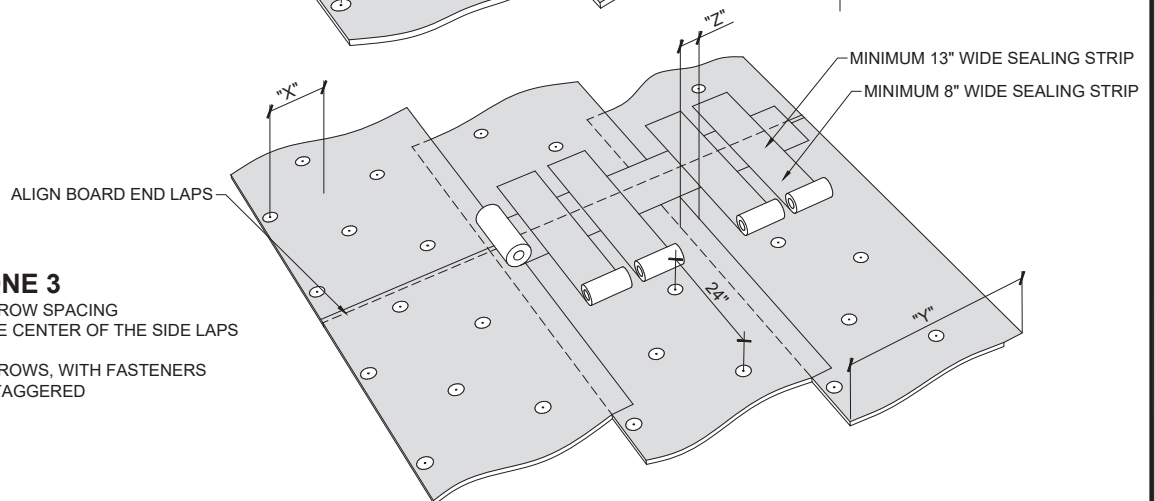

ZONE 3

- NOMINAL 40% OF FIELD ROW SPACING
- ONE (1) ROW WITHIN THE CENTER OF THE SIDE LAPS SPACED 24" O.C.
- TWO (2) INTERMEDIATE ROWS, WITH FASTENERS SPACED 24" O.C. AND STAGGERED

Roll Width (Y)	Lap Width (Z)	Zone	Pattern	Row Spacing (X)	Fasteners Per Square
39in (1m)	3in	1	24	36in	17
		2	24,24	18in	34
		3	24,24,24	12in	50

NOTES:

1. SOPREMA DETAIL DRAWINGS: REFER TO SOPREMA AND OTHER RELATED PUBLISHED DOCUMENTATION, PRODUCT DATA SHEETS (PDS) AND SAFETY DATA SHEETS (SDS) FOR ADDITIONAL INFORMATION. ALL DETAIL DRAWINGS AND RELATED INSTALLATION GUIDELINES ARE PROVIDED BY SOPREMA FOR THE SOLE PURPOSE OF ISSUING A SOPREMA WARRANTY. ACCORDINGLY, THE DETAIL DRAWINGS ARE NOT OFFERED, AND SHOULD NOT BE CONSIDERED, AS A SUBSTITUTE FOR PROFESSIONAL DESIGN SERVICES.
2. SOPREMA NOR ITS EMPLOYEES ARE DESIGNER OF RECORD FOR ANY PROJECT. FASTENING PATTERNS PROVIDED BY SOPREMA ARE FOR SOPREMA WARRANTY PURPOSES ONLY. REFER TO LOCAL BUILDING CODES, DESIGNER OF RECORD DOCUMENTS, AND JURISDICTIONAL/AGENCY APPROVALS FOR PROJECT-SPECIFIC FASTENING REQUIREMENTS.



US CORPORATE ADDRESS
310 QUADRAL DRIVE
WADSWORTH, OHIO 44281
www.soprema.us
Tel:330.334.0066

PROJECT:

TITLE:

SBS LAMINATED COVERBOARD,
24" O.C. IN LAP
AND PRESCRIPTIVE ENHANCEMENTS

DRAWN BY: SOPREMA TECHNICAL SUPPORT, GGALLOWAY

NO.:

REVISION:

DATE:

DATE: 4.3.2020

SCALE: NTS

DRAWING NUMBER:
US.FP.19.01